



**PULLERS**



**ASCOT**



**AUR**



**BELL**



**BELT**



**CHAIN**



**CUP**



**DRAHT**



**FLACH**



**FLACH21**



**FLACH DP**



**FLAT**



**FLAT21**



**FLIP**



**GEBOG**



**GEBOG DP**



**GERADE**



**GOLF**



**HOSEN**



**KETTE**



**KTA**



**KUKE**



**LANG**



**LANG31**



**LCP**



**LINEA**



**LOOP**



**NET**



**RING**



**RIRI92**



**RUND**



**SPIN**



**SPITZ**



**STAB**



**STARRE**



**SUB**



**SWAR**



**TROPF**



**TROPF19**



**ZUFF**

# ASCOT

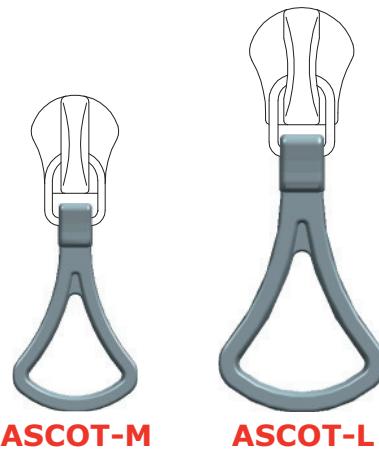

Metal



**material DIE CAST ZAMAK**  
materiale ZAMA PRESSOFUSA

**logo NONE**  
logo NESSUNO

**orientation DOUBLE FACE**  
orientamento BIFACCIALE

<b>puller dimension</b> dimensione tiretto	XS	S	M	L	XL	
<b>chain dimension</b> dimensione catena	3	4	6	8	10	14
<b>chain type</b> tipo catena	ME	●	†	†		●
	DE	●	†	†		●
	SI	●	†	†		
	TP			†	†	†
	SO			†	†	†
	HA		●	†	†	

†available disponibile ● on request su richiesta

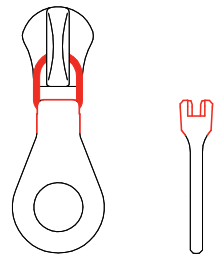

**link type LOOP**  
tipo attacco GANCIO

# AUR

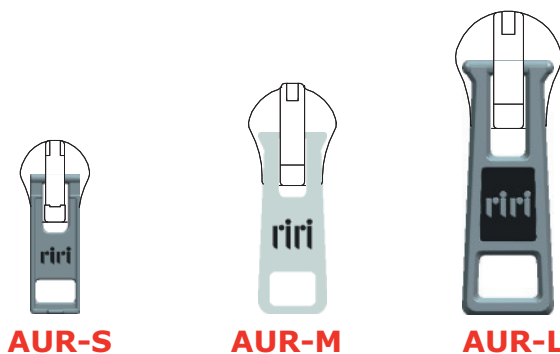

**material DIE CAST ZAMAK (S-L)**  
**MILLED STEEL (M)**  
materiale ZAMA PRESSOFUSA (S-L)  
ACCIAIO TRANCIATO (M)

**logo EMBOSSED (S-L) ENGRAVED (M)**  
logo IN RILIEVO (S-L) INCISO (M)

**orientation DOUBLE FACE**  
orientamento BIFACCIALE

<b>puller dimension</b> dimensione tiretto	XS	S	M	L	XL	
<b>chain dimension</b> dimensione catena	3	4	6	8	10	14
<b>chain type</b> tipo catena	ME		†	†	†	●
	DE		†	†	†	
	SI		†	†	†	
	TP			†	†	●
	SO			●	†	●
	HA			†	†	

†available disponibile ● on request su richiesta

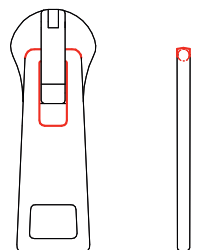

**link type ONE PIECE**  
tipo attacco PEZZO UNICO

# BELL



**material DIE CAST ZAMAK**  
materiale ZAMA PRESSOFUSA

**logo NONE**  
logo NESSUNO

**orientation DOUBLE FACE**  
orientamento BIFACCIALE



**BELL-M**

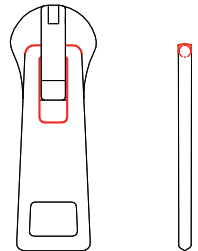

**link type ONE PIECE**  
tipo attacco PEZZO UNICO

<b>puller dimension</b> dimensione tiretto		XS	S	M	L	XL	
<b>chain dimension</b> dimensione catena		3	4	6	8	10	14
<b>chain type</b> tipo catena	ME			†	•		•
	DE			†	•		
	SI			†	•		
	TP			†	•	•	
	SO			•	•	•	
	HA			†	•		

†available disponibile • on request su richiesta

# BELT



**material DIE CAST ZAMAK**  
materiale ZAMA PRESSOFUSA

**logo NONE**  
logo NESSUNO

**orientation DOUBLE FACE**  
orientamento BIFACCIALE

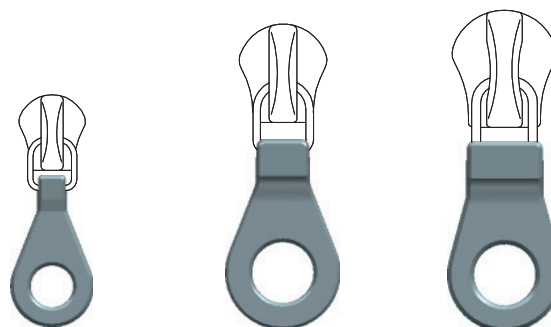

**BELT-S**

**BELT-M**

**BELT-L**

<b>puller dimension</b> dimensione tiretto		XS	S	M	L	XL	
<b>chain dimension</b> dimensione catena		3	4	6	8	10	14
<b>chain type</b> tipo catena	ME		†	†	†		•
	DE		†	†	†		•
	SI		†	†	†		
	TP	•		†	†	†	
	SO	•		†	†	†	
	HA		†	†	†		

†available disponibile • on request su richiesta

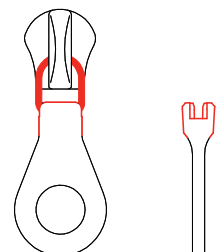

**link type LOOP**  
tipo attacco GANCIO

# CHAIN

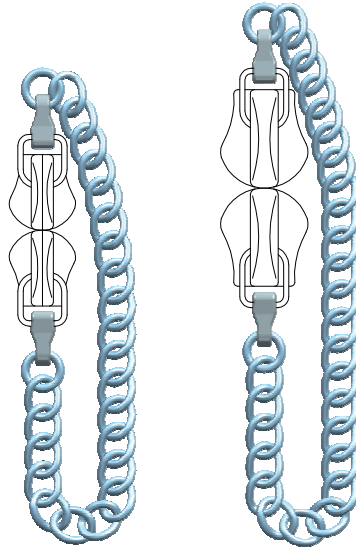

length equal to the zipper  
lunghezza pari alla cerniera

**CHAIN-S**

**CHAIN-M**



material **DIE CAST ZAMAK and STEEL**  
materiale ZAMA PRESSOFUSA e ACCIAIO

logo **NONE**  
logo NESSUNO

orientation **DOUBLE FACE**  
orientamento BIFACCIALE

puller dimension		dimensione tiretto		XS	S	M	L	XL	
chain dimension		dimensione catena		3	4	6	8	10	14
chain type	tipo catena	ME		•	•	•	•	•	•
		DE		•	•	•	•	•	•
		SI		•	•	•	•	•	•
		TP		•	•	•	•	•	•
		SO		•	•	•	•	•	•
		HA		•	•	•	•	•	•

• available disponibile    • on request su richiesta

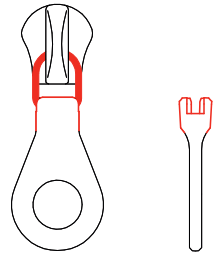

link type **LOOP**  
tipo attacco GANCIO

# CUP

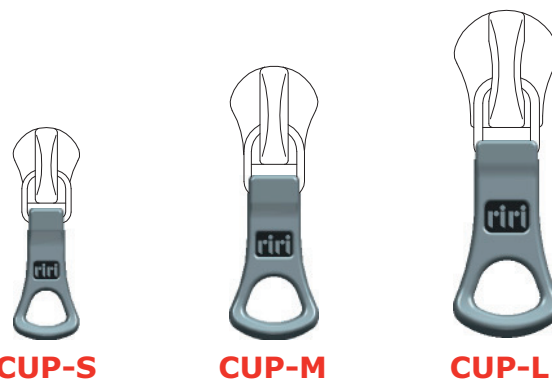

**CUP-S**

**CUP-M**

**CUP-L**



material **DIE CAST ZAMAK**  
materiale ZAMA PRESSOFUSA

logo **EMBOSSED**  
logo IN RILIEVO

orientation **DOUBLE FACE**  
orientamento BIFACCIALE

puller dimension		dimensione tiretto		XS	S	M	L	XL	
chain dimension		dimensione catena		3	4	6	8	10	14
chain type	tipo catena	ME		•	•	•	•	•	•
		DE		•	•	•	•	•	•
		SI		•	•	•	•	•	•
		TP		•	•	•	•	•	•
		SO		•	•	•	•	•	•
		HA		•	•	•	•	•	•

• available disponibile    • on request su richiesta

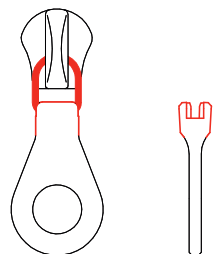

link type **LOOP**  
tipo attacco GANCIO

# DRAHT



**material STEEL**  
materiale ACCIAIO

**logo NONE**  
logo NESSUNO

**orientation DOUBLE FACE**  
orientamento BIFACCIALE

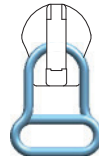

**DRAHT-S**

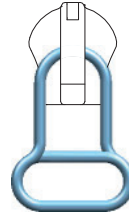

**DRAHT-M**

puller dimension		dimensione tiretto		XS	S	M	L	XL	
chain dimension		dimensione catena		3	4	6	8	10	14
chain type	tipo catena	ME		•	•	•			
	DE		•	•	•				
	SI		•	•	•				
	TP				•	•	•		
	SO					•	•	•	
	HA						•	•	

• available disponibile • on request su richiesta

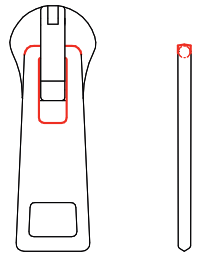

**link type ONE PIECE**  
tipo attacco PEZZO UNICO

# FLACH



**material DIE CAST ZAMAK**  
materiale ZAMA PRESSOFUSA

**logo EMBOSSED**  
logo IN RILIEVO

**orientation DOUBLE FACE**  
orientamento BIFACCIALE



**FLACH-S**

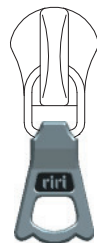

**FLACH-M**

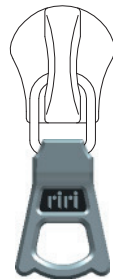

**FLACH-L**

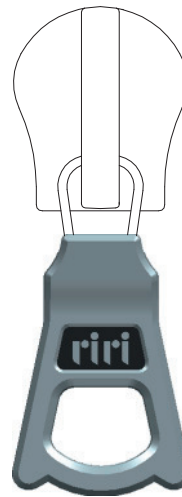

**FLACH-XL**

puller dimension		dimensione tiretto		XS	S	M	L	XL	
chain dimension		dimensione catena		3	4	6	8	10	14
chain type	tipo catena	ME			•	•	•		•
	DE		•	•	•				•
	SI		•	•	•				
	TP	•			•	•	•		
	SO	•			•	•	•		
	HA		•	•	•				

• available disponibile • on request su richiesta

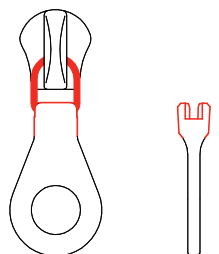

**link type LOOP**  
tipo attacco GANCIO

# FLACH21



**material DIE CAST ZAMAK**  
materiale ZAMA PRESSOFUSA

**logo EMBOSSED**  
logo IN RILIEVO

**orientation DOUBLE FACE**  
orientamento BIFACCIALE

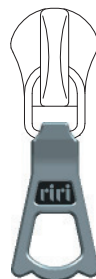

**FLACH21-M**

<b>puller dimension</b> dimensione tiretto	XS	S	M	L	XL	
<b>chain dimension</b> dimensione catena	3	4	6	8	10	14
<b>chain type</b> tipo catena	ME	●	†	●		●
	DE	●	†	●		●
	SI	●	†	●		
	TP			†	●	●
	SO			†	●	●
	HA		●	†	●	

† **available** disponibile    ● **on request** su richiesta

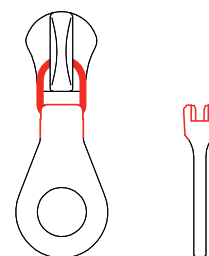

**link type LOOP**  
tipo attacco GANCIO

# FLACH DP



**material ZAMAK DIE CASTING**  
materiale ZAMA PRESSOFUSA

**logo EMBOSSED**  
logo IN RILIEVO

**orientation DOUBLE FACE**  
orientamento BIFACCIALE



**FLACH-M DP**

<b>puller dimension</b> dimensione tiretto	XS	S	M	L	XL	
<b>chain dimension</b> dimensione catena	3	4	6	8	10	14
<b>chain type</b> tipo catena	ME		†			
	DE			†		
	SI			†		
	TP			†		
	SO					
	HA			†		

† **available** disponibile    ● **on request** su richiesta

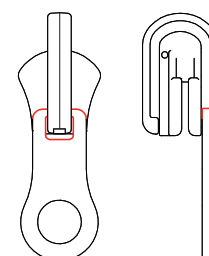

**link type REVERSIBLE**  
tipo attacco REVERSIBILE

# FLAT



**material DIE CAST ZAMAK**  
materiale ZAMA PRESSOFUSA

**logo NONE**  
logo NESSUNO

**orientation DOUBLE FACE**  
orientamento BIFACCIALE

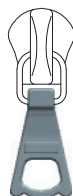

**FLAT-S**



**FLAT-M**

puller dimension		dimensione tiretto					
chain dimension		dimensione catena					
		XS	S	M	L	XL	
		3	4	6	8	10	14
chain type	tipo catena						
	ME		•	•	•		•
	DE		•	•	•		•
	SI		•	•	•		
	TP	•		•	•	•	
	SO	•		•	•	•	
	HA		•	•	•		

• available disponibile    • on request su richiesta

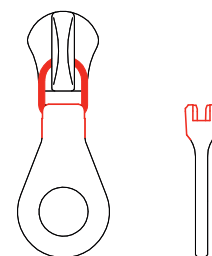

**link type LOOP**  
tipo attacco GANCIO

# FLAT21



**material DIE CAST ZAMAK**  
materiale ZAMA PRESSOFUSA

**logo NONE**  
logo NESSUNO

**orientation DOUBLE FACE**  
orientamento BIFACCIALE

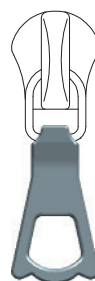

**FLAT21-M**

puller dimension		dimensione tiretto					
chain dimension		dimensione catena					
		XS	S	M	L	XL	
		3	4	6	8	10	14
chain type	tipo catena						
	ME		•	•	•		•
	DE		•	•	•		•
	SI		•	•	•		
	TP			•	•	•	
	SO			•	•	•	
	HA		•	•	•		

• available disponibile    • on request su richiesta

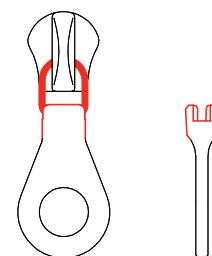

**link type LOOP**  
tipo attacco GANCIO



# FLIP



**material DIE CAST ZAMAK**  
materiale ZAMA PRESSOFUSA

**logo NONE**  
logo NESSUNO

**orientation DOUBLE FACE**  
orientamento BIFACCIALE



**FLIP-M**

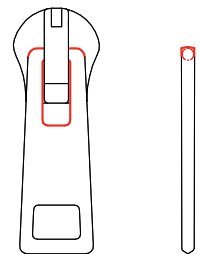

**link type ONE PIECE**  
tipo attacco PEZZO UNICO

<b>puller dimension</b>	dimensione tiretto	XS	S	M	L	XL	
<b>chain dimension</b>	dimensione catena	3	4	6	8	10	14
<b>chain type</b> tipo catena	ME		●	┆	●		●
	DE		●	┆	●		
	SI		●	┆	●		
	TP			┆	●	●	
	SO			┆	●	●	
	HA			┆	●		

┆ **available** disponibile    ● **on request** su richiesta

# GEBOG



**material DIE CAST ZAMAK**  
materiale ZAMA PRESSOFUSA

**logo NONE**  
logo NESSUNO

**orientation SINGLE FACED**  
orientamento MONOFACCIALE

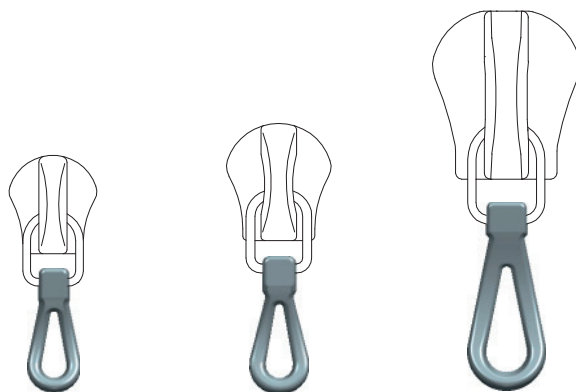

**GEBOG-M**

**GEBOG-L**

**GEBOG-XL**

<b>puller dimension</b>	dimensione tiretto	XS	S	M	L	XL	
<b>chain dimension</b>	dimensione catena	3	4	6	8	10	14
<b>chain type</b> tipo catena	ME		●	┆	┆		┆
	DE		●	┆	┆		┆
	SI		●	┆	┆		
	TP			┆	┆	┆	
	SO			┆	┆	┆	
	HA		●	┆	┆		

┆ **available** disponibile    ● **on request** su richiesta

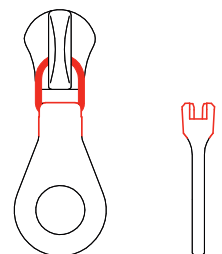

**link type LOOP**  
tipo attacco GANCIO

# GEBOG DP



**material DIE CAST ZAMAK**  
materiale ZAMA PRESSOFUSA

**logo NONE**  
logo NESSUNO

**orientation SINGLE FACED**  
orientamento MONOFACCIALE

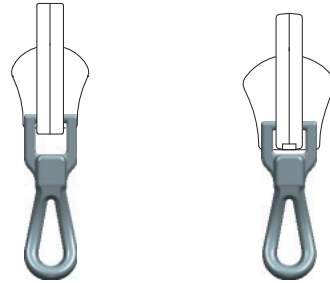

**GEBOG-S DP GEBOG-M DP**

<b>puller dimension</b> dimensione tiretto		XS	S	M	L	XL	
<b>chain dimension</b> dimensione catena		3	4	6	8	10	14
<b>chain type</b> tipo catena	ME		•	•			
	DE			•			
	SI		•	•			
	TP			•			
	SO						
	HA			•			

• **available** disponibile    • **on request** su richiesta

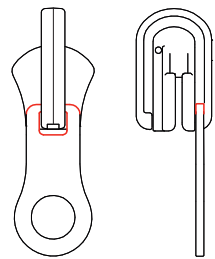

**link type REVERSIBLE**  
tipo attacco REVERSIBILE

# GERADE



**material STAMPED BRASS**  
materiale OTTONE TRANCIATO

**logo ENGRAVED**  
logo INCISO

**orientation DOUBLE FACE**  
orientamento BIFACCIALE

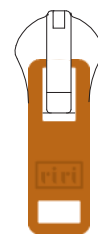

**GERADE-M**

<b>puller dimension</b> dimensione tiretto		XS	S	M	L	XL	
<b>chain dimension</b> dimensione catena		3	4	6	8	10	14
<b>chain type</b> tipo catena	ME		•	•			
	DE		•	•			
	SI		•	•			
	TP			•			
	SO			•			
	HA			•			

• **available** disponibile    • **on request** su richiesta

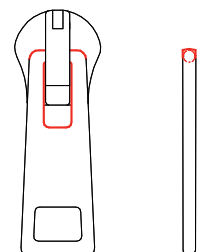

**link type ONE PIECE**  
tipo attacco PEZZO UNICO

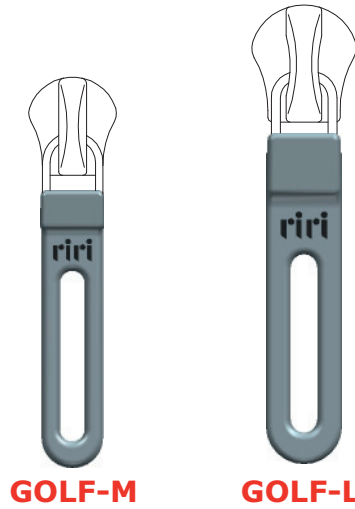

**material DIE CAST ZAMAK**  
materiale ZAMA PRESSOFUSA

**logo EMBOSSED**  
logo IN RILIEVO

**orientation DOUBLE FACE**  
orientamento BIFACCIALE

puller dimension		dimensione tiretto					
chain dimension		dimensione catena					
		XS	S	M	L	XL	
chain type	tipo catena						
	ME		●	♣	♣		●
	DE		●	♣	♣		●
	SI		●	♣	♣		
	TP			♣	♣	♣	
	SO			♣	♣	♣	
HA			●	♣	♣		

♣ available disponibile    ● on request su richiesta

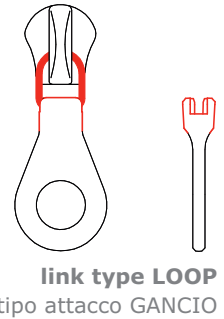

**link type LOOP**  
tipo attacco GANCIO

# HOSEN

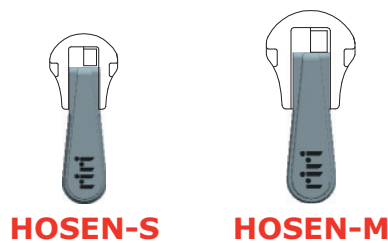

**material DIE CAST ZAMAK**  
materiale ZAMA PRESSOFUSA

**logo EMBOSSED**  
logo IN RILIEVO

**orientation SINGLE FACED**  
orientamento MONOFACCIALE

puller dimension		dimensione tiretto					
chain dimension		dimensione catena					
		XS	S	M	L	XL	
chain type	tipo catena						
	ME		♣	♣			
	DE		♣	♣			
	SI		♣	♣			
	TP			♣			
	SO			♣			
HA				♣			

♣ available disponibile    ● on request su richiesta

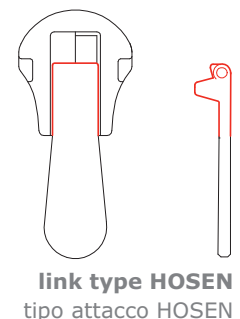

**link type HOSEN**  
tipo attacco HOSEN

# KETTE

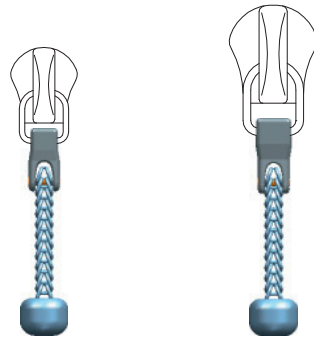

**KETTE-S**

**KETTE-M**



**material DIE CAST ZAMAK and STEEL**  
materiale ZAMA PRESSOFUSA e ACCIAIO

**logo NONE**  
logo NESSUNO

**orientation DOUBLE FACE**  
orientamento BIFACCIALE

puller dimension		dimensione tiretto					
chain dimension		dimensione catena					
		XS	S	M	L	XL	
chain type	tipo catena						
	ME		•	•	•		•
	DE		•	•	•		•
	SI		•	•	•		
	TP	•		•	•	•	
	SO	•		•	•	•	
HA		•	•	•			

• available disponibile    • on request su richiesta

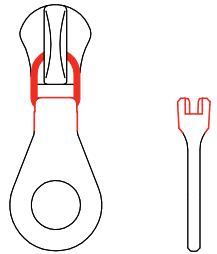

**link type LOOP**  
tipo attacco GANCIO

# KTA

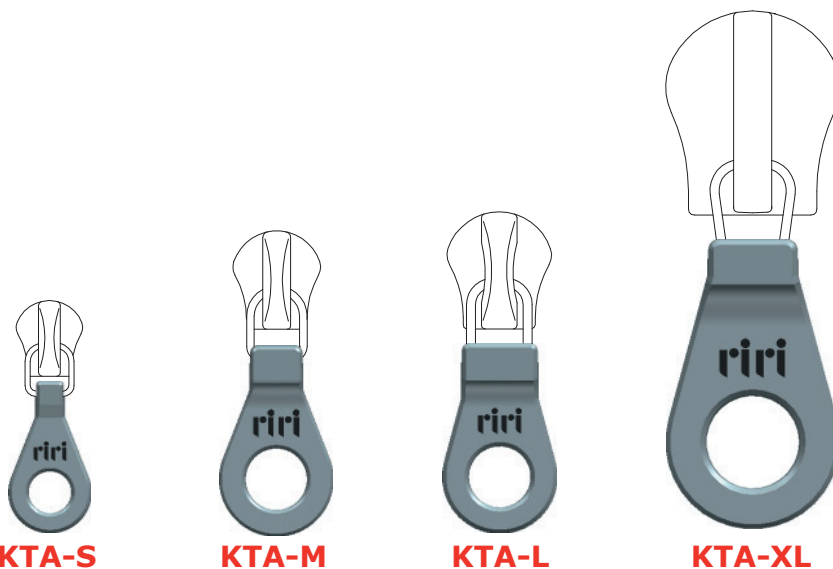

**KTA-S**

**KTA-M**

**KTA-L**

**KTA-XL**



**material DIE CAST ZAMAK**  
materiale ZAMA PRESSOFUSA

**logo ENGRAVED**  
logo INCISO

**orientation DOUBLE FACE**  
orientamento BIFACCIALE

puller dimension		dimensione tiretto					
chain dimension		dimensione catena					
		XS	S	M	L	XL	
chain type	tipo catena						
	ME		•	•	•		•
	DE		•	•	•		•
	SI		•	•	•		
	TP	•		•	•	•	
	SO	•		•	•	•	
HA		•	•	•			

• available disponibile    • on request su richiesta

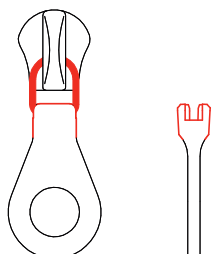

**link type LOOP**  
tipo attacco GANCIO

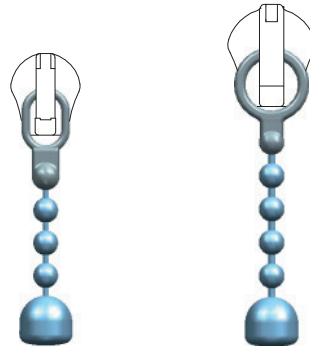

**KUKE-S**

**KUKE-M**

**material DIE CAST ZAMAK and STEEL**  
materiale ZAMA PRESSOFUSA e ACCIAIO

**logo NONE**  
logo NESSUNO

**orientation SINGLE FACED**  
orientamento MONOFACCIALE

puller dimension		dimensione tiretto					
chain dimension		dimensione catena					
		XS	S	M	L	XL	
chain type	tipa catena						
	ME		•	•	•		•
	DE		•	•	•		
	SI		•	•	•		
	TP			•	•	•	
	SO			•	•	•	
HA			•	•			

• available disponibile    • on request su richiesta

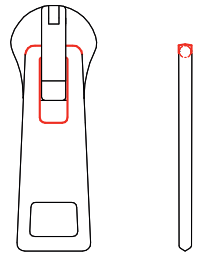

**link type ONE PIECE**  
tipo attacco PEZZO UNICO

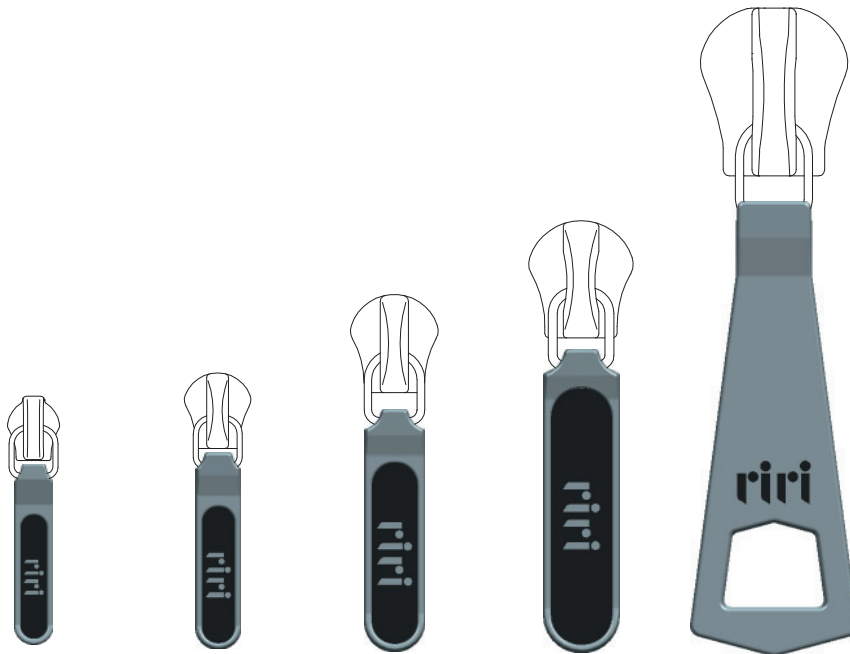

**LANG-XS**

**LANG-S**

**LANG-M**

**LANG-L**

**LANG-XL**

**material DIE CAST ZAMAK**  
materiale ZAMA PRESSOFUSA

**logo EMBOSSED**  
logo IN RILIEVO

**orientation DOUBLE FACE**  
orientamento BIFACCIALE

puller dimension		dimensione tiretto					
chain dimension		dimensione catena					
		XS	S	M	L	XL	
chain type	tipa catena						
	ME		•	•	•		•
	DE		•	•	•		•
	SI		•	•	•		
	TP	•		•	•	•	
	SO	•		•	•	•	
HA		•	•	•			

• available disponibile    • on request su richiesta

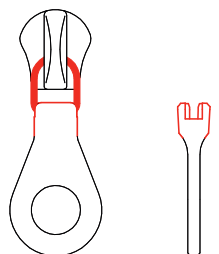

**link type LOOP**  
tipo attacco GANCIO

# LANG31



**material DIE CAST ZAMAK**  
materiale ZAMA PRESSOFUSA

**logo EMBOSSED**  
logo IN RILIEVO

**orientation DOUBLE FACE**  
orientamento BIFACCIALE



**LANG31-M**

<b>puller dimension</b> dimensione tiretto		XS	S	M	L	XL	
<b>chain dimension</b> dimensione catena		3	4	6	8	10	14
<b>chain type</b> tipo catena	ME		●	☑	●		●
	DE		●	☑	●		
	SI		●	☑	●		
	TP			☑	●	●	
	SO			☑	●	●	
	HA			☑	●		

☑ **available** disponibile    ● **on request** su richiesta

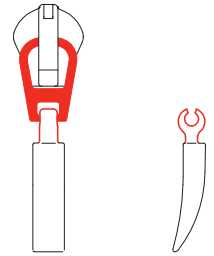

**link type CLAW**  
tipo attacco GANASCIA

# LCP



**material DIE CAST ZAMAK**  
materiale ZAMA PRESSOFUSA

**logo ENGRAVED and ENAMELLED**  
logo INCISO e SMALTATO

**orientation SINGLE FACED**  
orientamento MONOFACCIALE



**LCP-L**

<b>puller dimension</b> dimensione tiretto		XS	S	M	L	XL	
<b>chain dimension</b> dimensione catena		3	4	6	8	10	14
<b>chain type</b> tipo catena	ME			●	☑		●
	DE			●	☑		●
	SI			●	☑		
	TP			●	☑	☑	
	SO			●	☑	☑	
	HA			●	☑		

☑ **available** disponibile    ● **on request** su richiesta

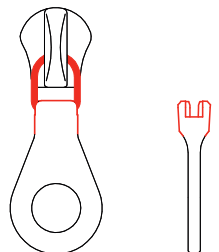

**link type LOOP**  
tipo attacco GANCIO



**LINEA-M**



**material DIE CAST ZAMAK**  
materiale ZAMA PRESSOFUSA

**logo EMBOSSED**  
logo IN RILIEVO

**orientation DOUBLE FACE**  
orientamento BIFACCIALE

<b>puller dimension</b> dimensione tiretto		XS	S	M	L	XL	
<b>chain dimension</b> dimensione catena		3	4	6	8	10	14
<b>chain type</b> tipo catena	ME		●	†	●		●
	DE		●	†	●		●
	SI		●	†	●		
	TP			†	●	●	
	SO			†	●	●	
	HA		●	†	●		

†available disponibile ● on request su richiesta

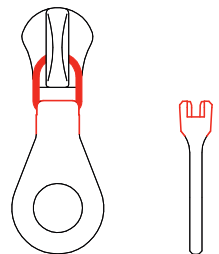

**link type LOOP**  
tipo attacco GANCIO

# LOOP

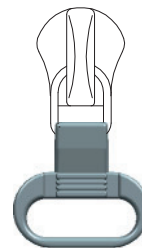

**LOOP-M**



**material DIE CAST ZAMAK**  
materiale ZAMA PRESSOFUSA

**logo NONE**  
logo NESSUNO

**orientation DOUBLE FACE**  
orientamento BIFACCIALE

<b>puller dimension</b> dimensione tiretto		XS	S	M	L	XL	
<b>chain dimension</b> dimensione catena		3	4	6	8	10	14
<b>chain type</b> tipo catena	ME		●	†	●		●
	DE		●	†	●		●
	SI		●	†	●		
	TP			†	●	●	
	SO			†	●	●	
	HA		●	†	●		

†available disponibile ● on request su richiesta

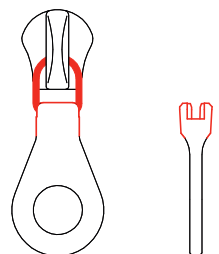

**link type LOOP**  
tipo attacco GANCIO



**material MICROCAST BRASS**  
materiale OTTONE MICROFUSO

**logo CUT OUT**  
logo PASSANTE

**orientation SINGLE FACED**  
orientamento MONOFACCIALE

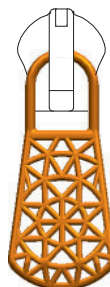

**NET-M**

<b>puller dimension</b> dimensione tiretto	XS	S	M	L	XL	
<b>chain dimension</b> dimensione catena	3	4	6	8	10	14
<b>chain type</b> tipo catena	ME	●	†	●		
	DE	●	†	●		
	SI	●	†	●		
	TP			†	●	
	SO			●	●	
	HA			†	●	

†available disponibile ● on request su richiesta

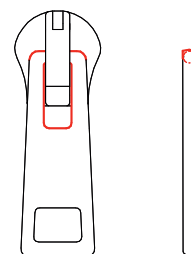

**link type ONE PIECE**  
tipo attacco PEZZO UNICO

# RING

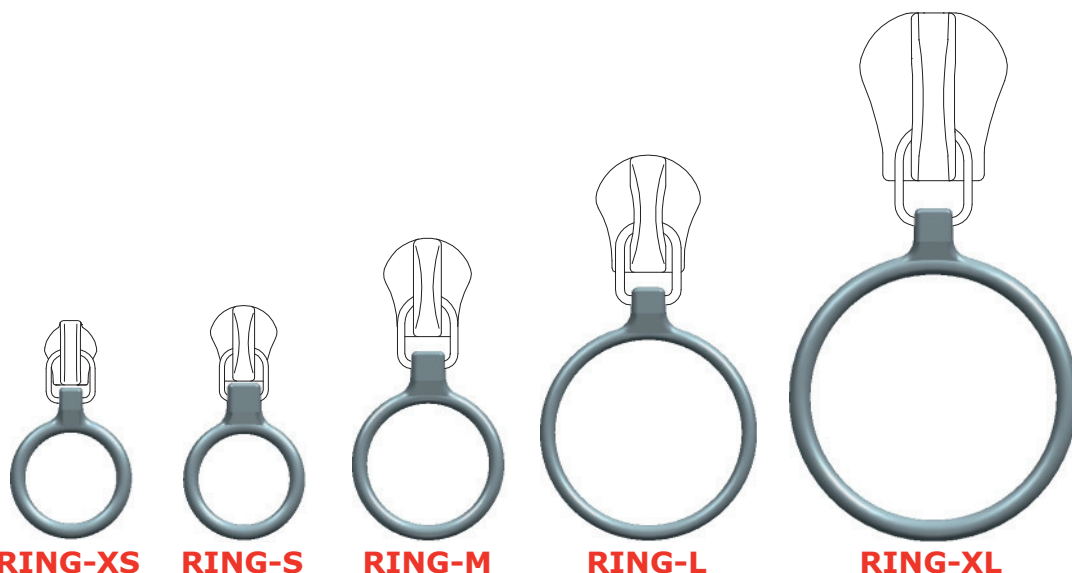

**material DIE CAST ZAMAK**  
materiale ZAMA PRESSOFUSA

**logo NONE**  
logo NESSUNO

**orientation DOUBLE FACE**  
orientamento BIFACCIALE

<b>puller dimension</b> dimensione tiretto	XS	S	M	L	XL	
<b>chain dimension</b> dimensione catena	3	4	6	8	10	14
<b>chain type</b> tipo catena	ME	†	†	†		†
	DE	†	†	†		†
	SI	†	†	†		
	TP	†		†	†	†
	SO	†		†	†	†
	HA		†	†	†	

†available disponibile ● on request su richiesta

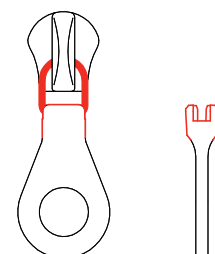

**link type LOOP**  
tipo attacco GANCIO





**material DIE CAST ZAMAK**  
materiale ZAMA PRESSOFUSA

**logo EMBOSSED**  
logo IN RILIEVO

**orientation SINGLE FACED**  
orientamento MONOFACCIALE

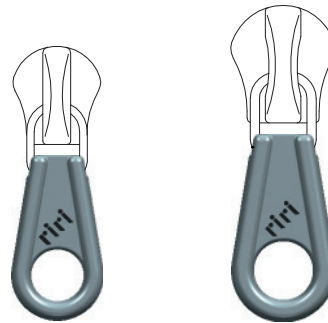

**RIRI92-M**

**RIRI92-L**

<b>puller dimension</b> dimensione tiretto	XS	S	M	L	XL	
<b>chain dimension</b> dimensione catena	3	4	6	8	10	14
<b>chain type</b> tipo catena	ME	●	✂	✂		●
	DE	●	✂	✂		●
	SI	●	✂	✂		
	TP			✂	✂	✂
	SO			✂	✂	✂
	HA		●	✂	✂	

✂ **available** disponibile    ● **on request** su richiesta

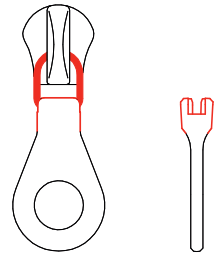

**link type LOOP**  
tipo attacco GANCIO

# RUND



**material STAMPED BRASS**  
materiale OTTONE TRANCIATO

**logo ENGRAVED**  
logo INCISO

**orientation DOUBLE FACE**  
orientamento BIFACCIALE

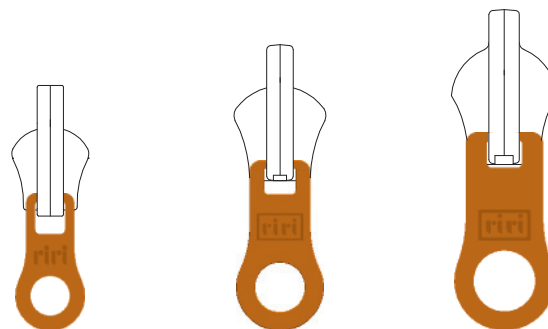

**RUND-S**

**RUND-M**

**RUND-L**

<b>puller dimension</b> dimensione tiretto	XS	S	M	L	XL	
<b>chain dimension</b> dimensione catena	3	4	6	8	10	14
<b>chain type</b> tipo catena	ME		✂	✂	✂	
	DE			✂	✂	
	SI		✂	✂	✂	
	TP			✂	✂	
	SO				✂	
	HA			✂	✂	

✂ **available** disponibile    ● **on request** su richiesta

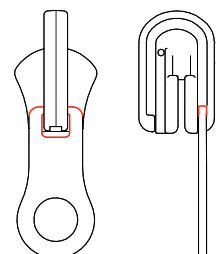

**link type REVERSIBLE**  
tipo attacco REVERSIBILE

# SPIN



**material DIE CAST ZAMAK**  
materiale ZAMA PRESSOFUSA

**logo EMBOSSED**  
logo IN RILIEVO

**orientation DOUBLE FACE**  
orientamento BIFACCIALE



**SPIN-M**

<b>puller dimension</b>	dimensione tiretto	XS	S	M	L	XL	
<b>chain dimension</b>	dimensione catena	3	4	6	8	10	14
<b>chain type</b> tipo catena	ME		●	†	●		●
	DE		●	†	●		●
	SI		●	†	●		
	TP			†	●	●	
	SO			†	●	●	
	HA		●	†	●		

†available disponibile    ● on request su richiesta

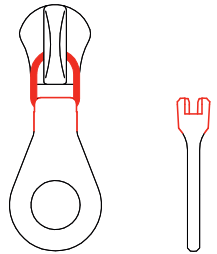

**link type LOOP**  
tipo attacco GANCIO

# SPITZ



**material DIE CASTING ZAMAK**  
materiale ZAMA PRESSOFUSA

**logo NONE**  
logo NESSUNO

**orientation DOUBLE FACE**  
orientamento BIFACCIALE



**SPITZ-M**

<b>puller dimension</b>	dimensione tiretto	XS	S	M	L	XL	
<b>chain dimension</b>	dimensione catena	3	4	6	8	10	14
<b>chain type</b> tipo catena	ME		●	†	●		
	DE		●	†	●		
	SI		●	†	●		
	TP			†	●		
	SO			†	●		
	HA			†	●		

†available disponibile    ● on request su richiesta

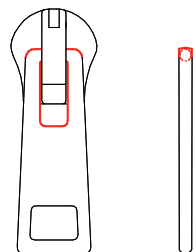

**link type ONE PIECE**  
tipo attacco PEZZO UNICO

# STAB

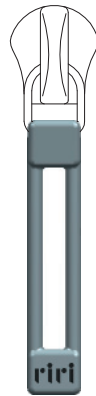

**STAB-M**



**STAB-L**



**material DIE CAST ZAMAK**  
materiale ZAMA PRESSOFUSA

**logo ENGRAVED (M) or NONE (L)**  
logo INCISO (M) o NESSUNO (L)

**orientation DOUBLE FACE**  
orientamento BIFACCIALE

<b>puller dimension</b> dimensione tiretto	XS	S	M	L	XL	
<b>chain dimension</b> dimensione catena	3	4	6	8	10	14
<b>chain type</b> tipo catena	ME	●	†	†		●
	DE	●	†	†		●
	SI	●	†	†		
	TP			†	†	†
	SO			†	†	†
	HA		●	†	†	

†available disponibile ● on request su richiesta

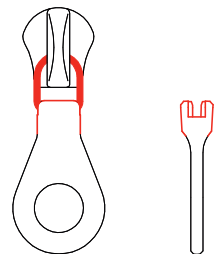

**link type LOOP**  
tipo attacco GANCIO

# STARRE



**material STAMPED BRASS**  
materiale OTTONE TRANCIATO

**logo ENGRAVED**  
logo INCISO

**orientation SINGLE FACED**  
orientamento MONOFACCIALE

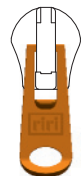

**STARRE-S**



**STARRE-M**

<b>puller dimension</b> dimensione tiretto	XS	S	M	L	XL	
<b>chain dimension</b> dimensione catena	3	4	6	8	10	14
<b>chain type</b> tipo catena	ME		†	†	●	
	DE		†	†	●	
	SI		†	†	●	
	TP			†	●	
	SO			†	●	
	HA			†	●	

†available disponibile ● on request su richiesta

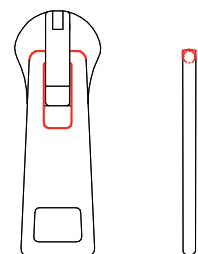

**link type ONE PIECE**  
tipo attacco PEZZO UNICO

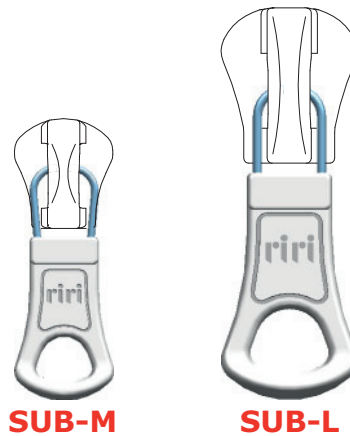

**material POLYAMIDE and STEEL**  
materiale POLIAMMIDE e ACCIAIO

**logo ENGRAVED**  
logo INCISO

**orientation DOUBLE FACE**  
orientamento BIFACCIALE

puller dimension		dimensione tiretto					
chain dimension		dimensione catena					
		XS	S	M	L	XL	
chain type	tipo catena						
	ME						
	DE		●	†	†	†	
	SI						
	TP						
	SO						
	HA		●	†	†	†	

†available disponibile ● on request su richiesta

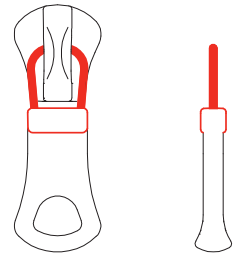

**link type CO-MOULDED**  
tipo attacco CO-STAMPATO



**material ZAMAK DIE CASTING and SWAROVSKI ELEMENTS**  
materiale ZAMA PRESSOFUSA e SWAROVSKI ELEMENTS

**logo ENGRAVED**  
logo INCISO

**orientation SINGLE FACED**  
orientamento MONOFACCIALE

puller dimension		dimensione tiretto					
chain dimension		dimensione catena					
		XS	S	M	L	XL	
chain type	tipo catena						
	ME		●	†	●		●
	DE		●	†	●		●
	SI		●	†	●		
	TP			†	●	●	
	SO			†	●	●	
	HA		●	†	●		

†available disponibile ● on request su richiesta

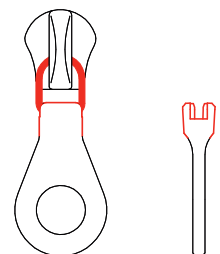

**link type LOOP**  
tipo attacco GANCIO



**TROPF-XS**



**TROPF-S**



**TROPF-M**

**material DIE CAST ZAMAK**  
materiale ZAMA PRESSOFUSA

**logo EMBOSSED or NONE (XS)**  
logo IN RILIEVO o NESSUNO (XS)

**orientation SINGLE FACED**  
orientamento MONOFACCIALE

puller dimension		dimensione tiretto					
chain dimension		dimensione catena					
		XS	S	M	L	XL	
chain type	tipo catena						
	ME		•	•	•		•
	DE		•	•	•		•
	SI		•	•	•		
	TP	•		•	•	•	
	SO	•		•	•	•	
HA		•	•	•			

• available disponibile    • on request su richiesta

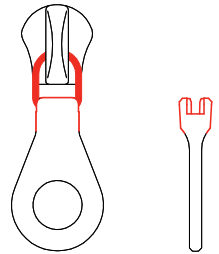

**link type LOOP**  
tipo attacco GANCIO

# TROPF19



**TROPF19-M**

**material DIE CAST ZAMAK**  
materiale ZAMA PRESSOFUSA

**logo EMBOSSED**  
logo IN RILIEVO

**orientation DOUBLE FACE**  
orientamento BIFACCIALE

puller dimension		dimensione tiretto					
chain dimension		dimensione catena					
		XS	S	M	L	XL	
chain type	tipo catena						
	ME		•	•	•		•
	DE		•	•	•		
	SI		•	•	•		
	TP			•	•	•	
	SO			•	•	•	
HA			•	•			

• available disponibile    • on request su richiesta

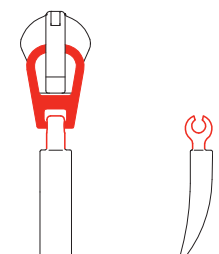

**link type CLAW**  
tipo attacco GANASCIA

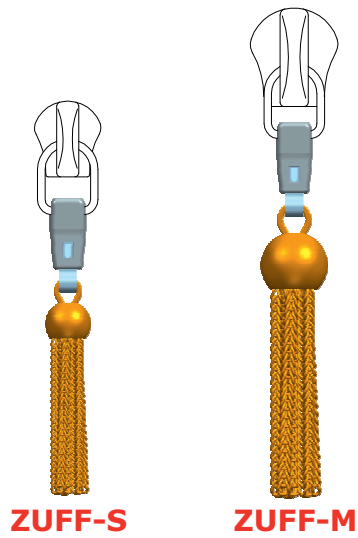

**material DIE CAST ZAMAK and BRASS**  
materiale ZAMA PRESSOFUSA e OTTONE

**logo NONE**  
logo NESSUNO

**orientation DOUBLE FACE**  
orientamento BIFACCIALE

<b>puller dimension</b> dimensione tiretto		XS	S	M	L	XL	
<b>chain dimension</b> dimensione catena		3	4	6	8	10	14
<b>chain type</b> tipo catena	ME		•	•	•		•
	DE		•	•	•		•
	SI		•	•	•		
	TP			•	•	•	
	SO			•	•	•	
	HA		•	•	•		

• **available** disponibile   
 • **on request** su richiesta

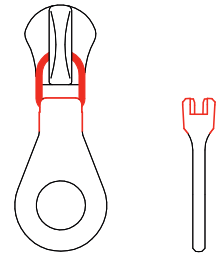

**link type LOOP**  
tipo attacco GANCIO



**LINK TYPES**

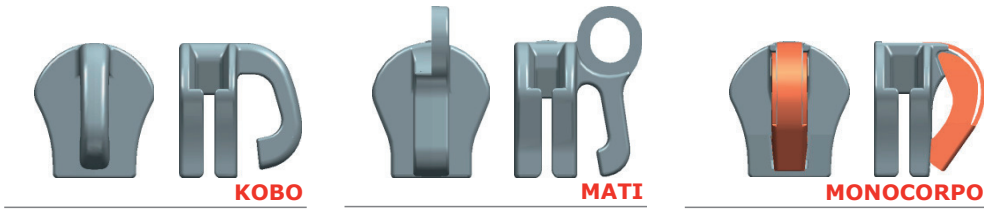
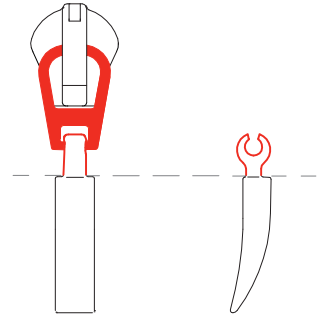

available body sliders corpi disponibili

**CO-MOULDED**  
CO-STAMPATO

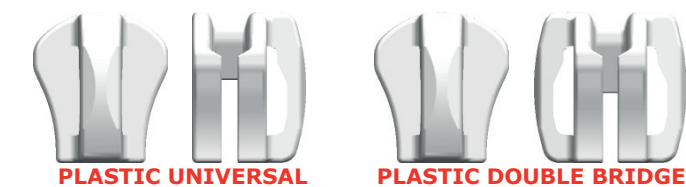
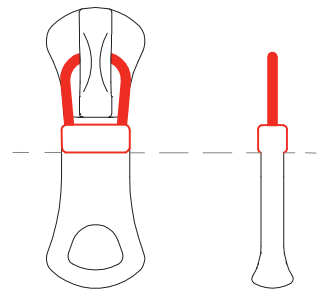

available body sliders corpi disponibili



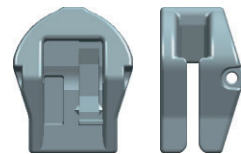
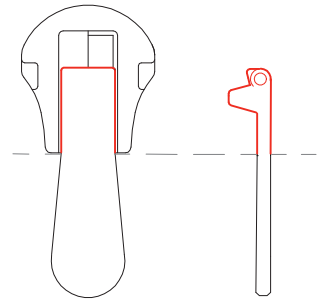

**HOSEN**

available body sliders corpi disponibili

# LOOP GANCIO

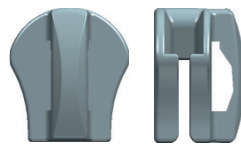
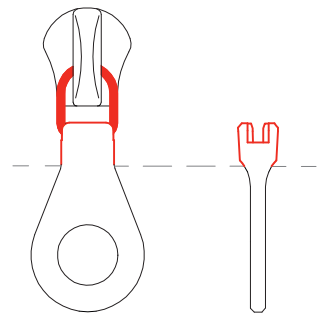

**UNIVERSAL**

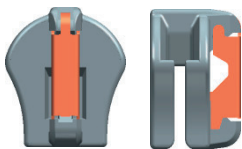

**3 PIECE**

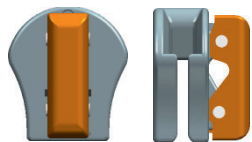

**BATA**

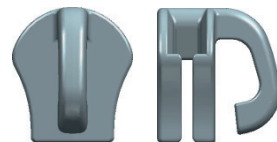

**KOBO**

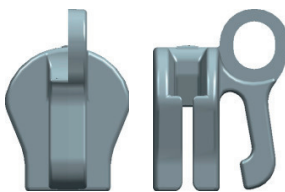

**MATI**

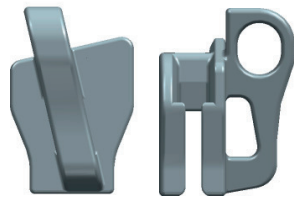

**SINUS**

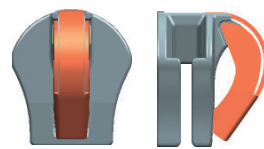

**MONOCORPO**

available body sliders corpi disponibili

# LOOP & PIN

SPINA

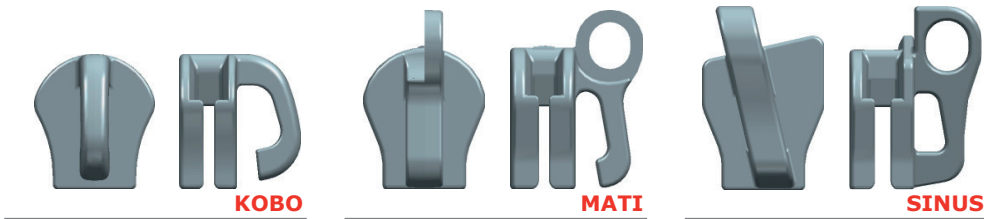
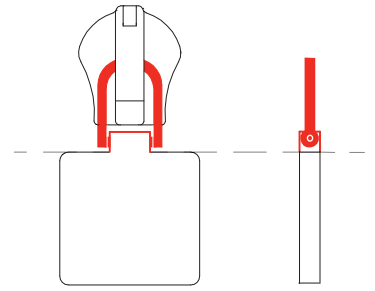

available body sliders corpi disponibili

# ONE PIECE

PEZZO UNICO

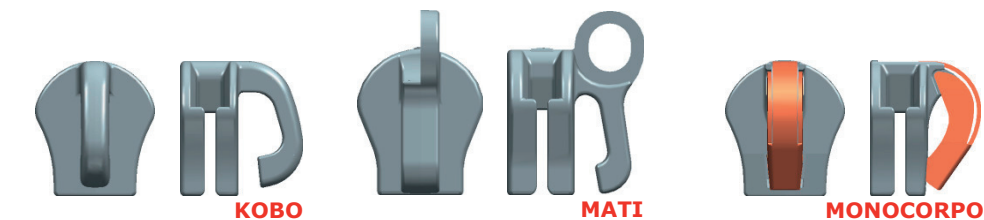
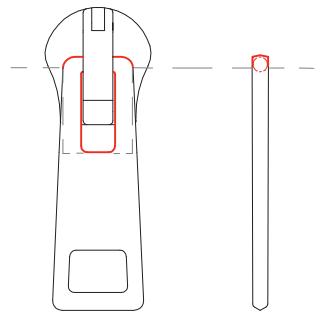

available body sliders corpi disponibili



# REVERSIBLE

REVERSIBILE

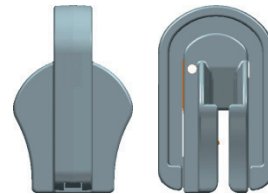
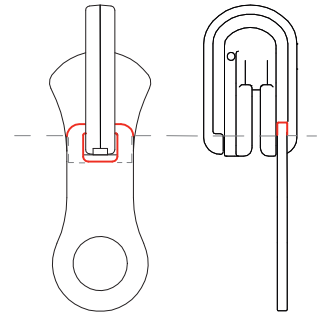

**REVERSIBLE**

available body sliders corpi disponibili



**BODY SLIDERS**



# UNIVERSAL

references  
sigle

**GA**  
non locking libero

**GT**  
locking bloccante

material DIE CAST ZAMAK  
materiale ZAMA PRESSOFUSA

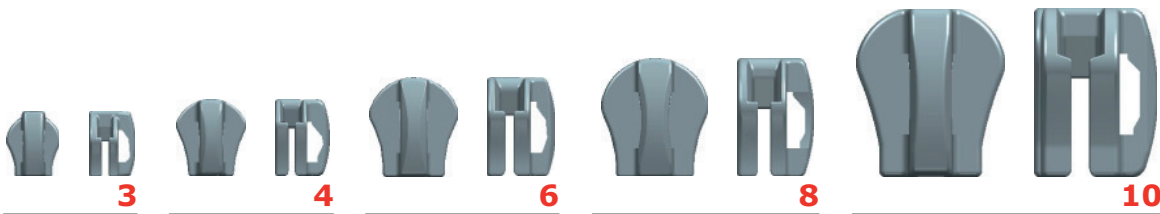

chain dimension    dimensione catena

	3	4	6	8	10	14
ME		r	r	r		
DE		r	r	r		
SI		r	r	r		
TP	r		r	r	r	
SO	r		r	r	r	
HA		r	r	r		

r available    disponibile    • on request    su richiesta

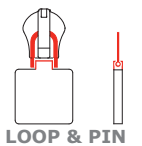
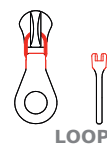

available link types  
tipi di attacco disponibili



# UNIVERSAL DOUBLE BRIDGE

DOPPIO PONTE

references  
sigle

**DGA**  
non locking libero

**DGT**  
locking bloccante

material DIE CAST ZAMAK  
materiale ZAMA PRESSOFUSA

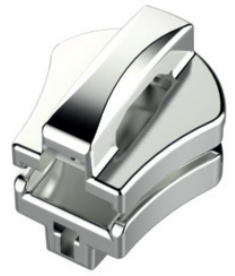

chain dimension    dimensione catena

	3	4	6	8	10	14
ME		•	•			
DE		•	•			•
SI		•	•			
TP			•			
SO						
HA			•			

• available    disponibile    • on request    su richiesta

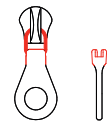

LOOP

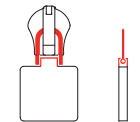

LOOP & PIN

available link types  
tipi di attacco disponibili

references  
sigle

**3A**  
non locking libero

**3T**  
locking bloccante

material DIE CAST ZAMAK  
and STEEL (spring)  
materiale ZAMA PRESSOFUSA  
e ACCIAIO (molletta)

## 3 PIECE 3 PEZZI

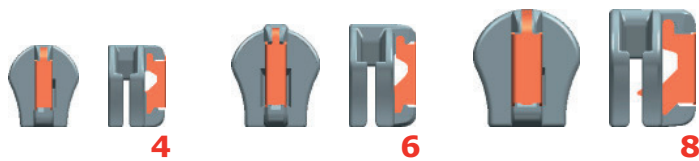

chain dimension    dimensione catena

	3	4	6	8	10	14
ME		•	•	•		
DE		•	•	•		
SI		•	•	•		
TP			•	•		
SO				•		
HA			•	•		

• available    disponibile    • on request    su richiesta

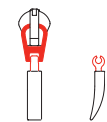

CLAW

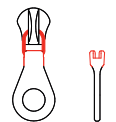

LOOP

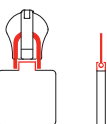

LOOP & PIN

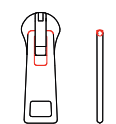

ONE PIECE

available link types  
tipi di attacco disponibili



# BATA

references  
sigle

**BA**  
non locking libero

**BT**  
locking bloccante

material **DIE CAST ZAMAK**  
and **BRASS (cap)**  
materiale ZAMA PRESSOFUSA  
e OTTONE (calotta)



chain dimension    dimensione catena

	3	4	6	8	10	14
chain type tipo catena	ME	•	•	•		
	DE			•	•	
	SI		•	•	•	
	TP			•	•	
	SO			•	•	
	HA			•		

• available    disponibile    • on request    su richiesta

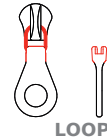

available link types  
tipi di attacco disponibili

# KOBO

references  
sigle

**BO**

material **DIE CAST ZAMAK**  
materiale ZAMA PRESSOFUSA

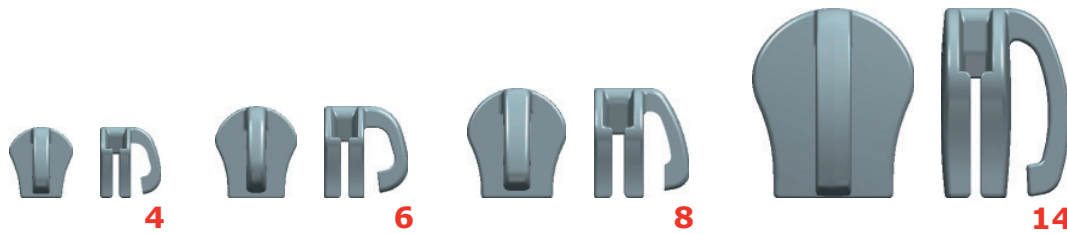

chain dimension    dimensione catena

	3	4	6	8	10	14
chain type tipo catena	ME	•	•	•		•
	DE		•	•	•	
	SI		•	•	•	
	TP			•	•	
	SO			•	•	
	HA			•	•	

• available    disponibile    • on request    su richiesta

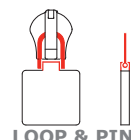
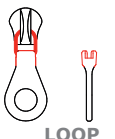

available link types  
tipi di attacco disponibili

references  
sigle

## BO.VAL

material DIE CAST ZAMAK  
materiale ZAMA PRESSOFUSA



chain dimension    dimensione catena

	3	4	6	8	10	14
ME			•	•		
DE			•			
SI			•	•		
TP			•	•	•	
SO				•	•	
HA						

• available    disponibile    
 • on request    su richiesta

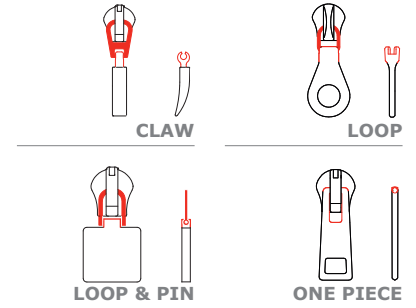

available link types  
tipi di attacco disponibili

# KOBO DOUBLE BRIDGE

DOPPIO PONTE KOBO

references  
sigle

## DBO

material DIE CAST ZAMAK  
materiale ZAMA PRESSOFUSA



chain dimension    dimensione catena

	3	4	6	8	10	14
ME		•				
DE						
SI		•				
TP						
SO						
HA						

• available    disponibile    
 • on request    su richiesta

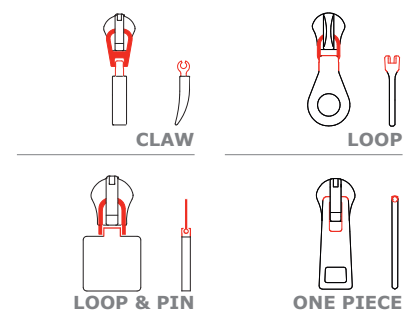

available link types  
tipi di attacco disponibili



references  
sigle

## MA

material DIE CAST ZAMAK  
materiale ZAMA PRESSOFUSA

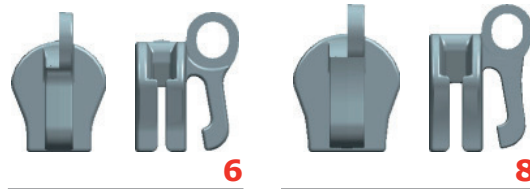

chain dimension    dimensione catena

	3	4	6	8	10	14
ME			•	•		
DE			•			
SI			•	•		
TP			•	•		
SO				•		
HA						

• available    disponibile    
 • on request    su richiesta

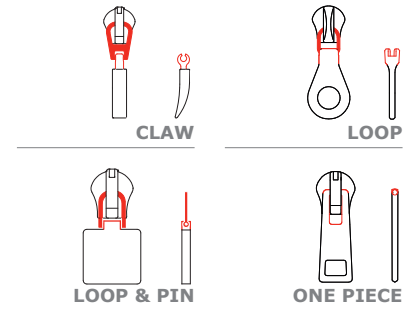

available link types  
tipi di attacco disponibili

## MATI BAGS MATI VALIGERIA

references  
sigle

## MA.VAL

material DIE CAST ZAMAK  
materiale ZAMA PRESSOFUSA

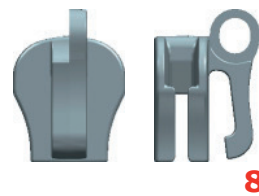

chain dimension    dimensione catena

	3	4	6	8	10	14
ME				•		
DE						
SI				•		
TP				•		
SO				•		
HA						

• available    disponibile    
 • on request    su richiesta

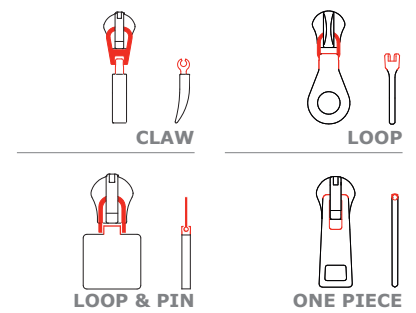

available link types  
tipi di attacco disponibili

references  
sigle

**SI**

material **DIE CAST ZAMAK**  
materiale ZAMA PRESSOFUSA

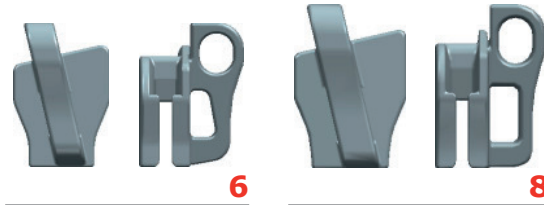

**chain dimension** dimensione catena

	3	4	6	8	10	14
<b>chain type</b> tipo catena						
ME				•		
DE			•			
SI				•		
TP			•	•		
SO				•		
HA						

• available disponibile • on request su richiesta

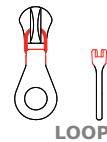

LOOP

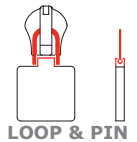

LOOP & PIN

available link types  
tipi di attacco disponibili

references  
sigle

**1A**  
non locking libero

**1T**  
locking bloccante

material **DIE CAST ZAMAK**  
and **STEEL (spring)**  
materiale ZAMA PRESSOFUSA  
e ACCIAIO (molletta)



**chain dimension** dimensione catena

	3	4	6	8	10	14
<b>chain type</b> tipo catena						
ME		•	•			
DE						
SI		•	•			
TP						
SO						
HA						

• available disponibile • on request su richiesta

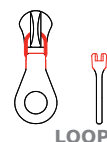

LOOP

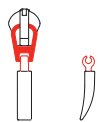

CLAW

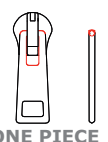

ONE PIECE

available link types  
tipi di attacco disponibili

references  
sigle

**HS**

material **DIE CAST ZAMAK**  
materiale ZAMA PRESSOFUSA

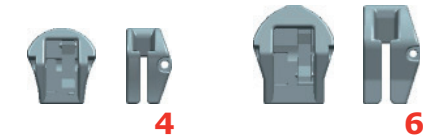

chain dimension    dimensione catena

	3	4	6	8	10	14	
chain type tipo catena	ME		•	•			
	DE		•	•			
	SI		•	•			
	TP			•	•		
	SO			•	•		
	HA			•	•		

• available    disponibile    • on request    su richiesta

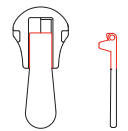

HOSEN

available link types  
tipi di attacco disponibili

references  
sigle

**DA**  
non locking libero

**DT**  
locking bloccante

material **DIE CAST ZAMAK**  
materiale ZAMA PRESSOFUSA

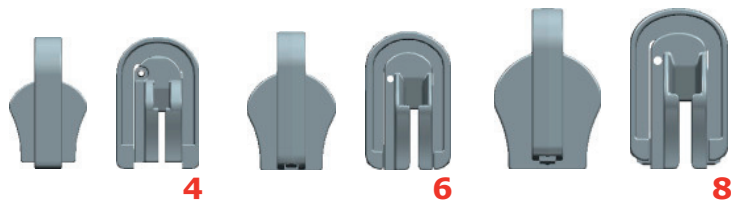

chain dimension    dimensione catena

	3	4	6	8	10	14	
chain type tipo catena	ME		•	•	•		
	DE			•	•		
	SI		•	•	•		
	TP			•	•		
	SO				•		
	HA			•	•		

• available    disponibile    • on request    su richiesta

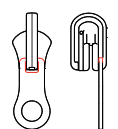

REVERSIBLE

available link types  
tipi di attacco disponibili



# PLASTIC UNIVERSAL

UNIVERSAL PLASTICO

references  
sigle

**PA**  
non locking libero

**PT**  
locking bloccante

material **POLYAMIDE**  
materiale POLIAMMIDE

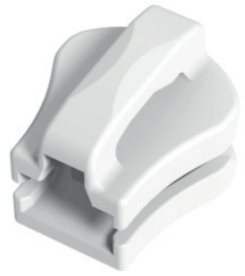

chain dimension dimensione catena

	3	4	6	8	10	14
chain type tipo catena	ME					
	DE			•	•	•
	SI					
	TP					
	SO					
	HA			•	•	•

• available disponibile • on request su richiesta

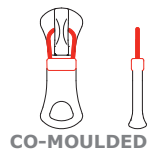

available link types  
tipi di attacco disponibili

# PLASTIC DOUBLE BRIDGE

DOPPIO PONTE PLASTICO

references  
sigle

**DPA**  
non locking libero

**DPT**  
locking bloccante

material **POLYAMIDE**  
materiale POLIAMMIDE



chain dimension dimensione catena

	3	4	6	8	10	14
chain type tipo catena	ME					
	DE			•	•	•
	SI					
	TP					
	SO					
	HA			•	•	•

• available disponibile • on request su richiesta

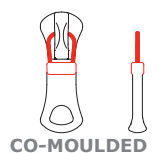

available link types  
tipi di attacco disponibili



# **FUNCTIONAL COMPONENTS**



# JUNCTIONS

SNODI

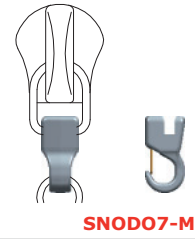
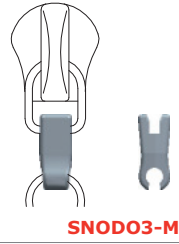
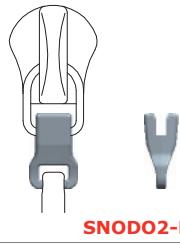

SNODO7-S

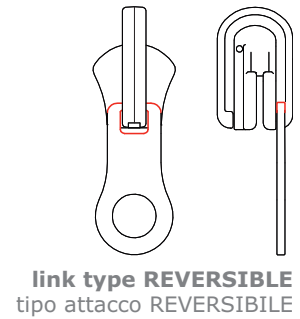
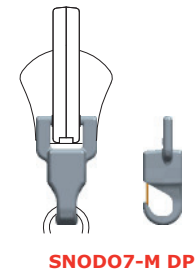
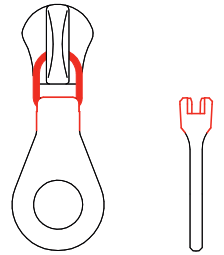

# RINGS

ANELLI

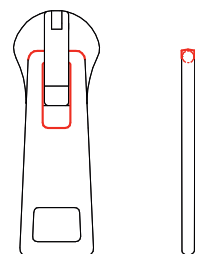



# STAFFE

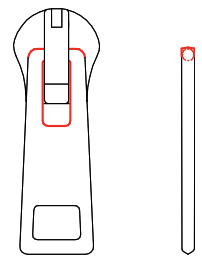
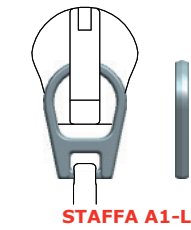
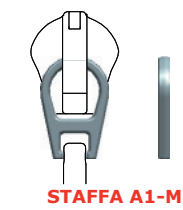
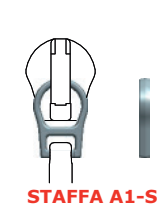
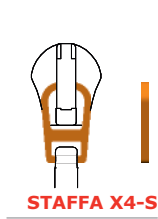

**link type ONE PIECE**  
tipo attacco PEZZO UNICO

# STAFFE

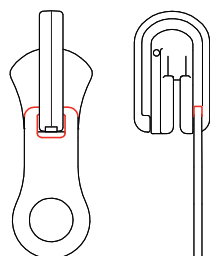
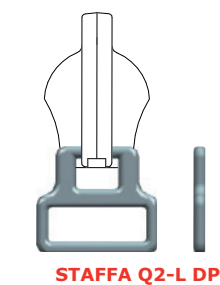
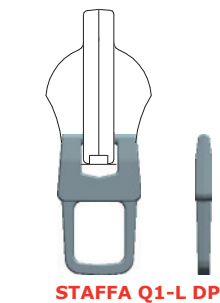
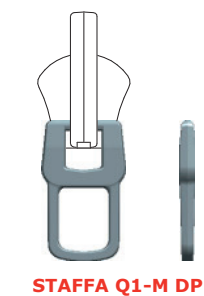
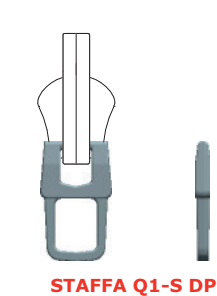
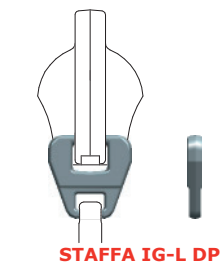
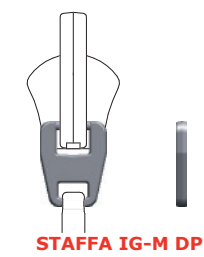
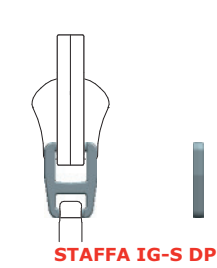

**link type REVERSIBLE**  
tipo attacco REVERSIBILE



# STAFFE

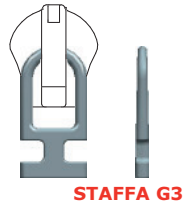

STAFFA G3



STAFFA G13



STAFFA G10



STAFFA G12



STAFFA G17



STAFFA G5



STAFFA G9

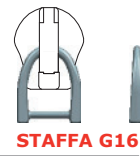

STAFFA G16



STAFFA G15

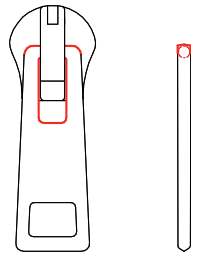

link type ONE PIECE  
tipo attacco PEZZO UNICO

# STAFFE

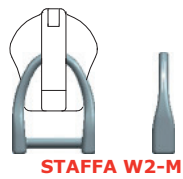

STAFFA W2-M

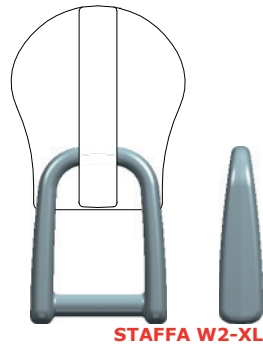

STAFFA W2-XL



STAFFA GH

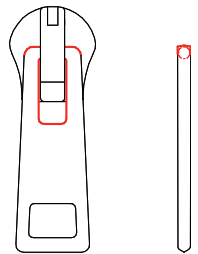

link type ONE PIECE  
tipo attacco PEZZO UNICO

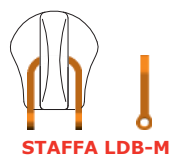

STAFFA LDB-M

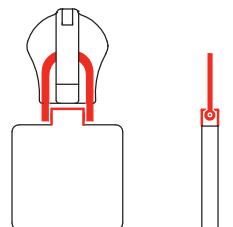

link type LOOP & PIN  
tipo attacco SPINA